

IN PURSUIT OF GROWTH & EXCELLENCE



EtherCAT[®]
Conformance tested

Ultra-evolutional

SDP Series AC SERVO SYSTEM

The Best Drive for Smart Machinery



www.seecfa.com

SDP Series

Ultra-evolutional Design

Advanced Utility for
Industrial Equipment



INDEX

Features	2
Servo Motors Model Definition	4
Servo Drives Model Definition	4
Servo Motor Specifications	5
Servo Drive Specifications	7
Wiring Diagram	8
Connections with Peripheral Equipment	11
Servo Drive Dimensions	12
Servo Motor Torque Curves	13
Servo Motor Dimensions	15
Optional Accessories	17
EtherCAT Master Controller Information	18

Features

One touch tuning



"Simple tuning" reduces the adjustment time effectively and maximizes the performance of the driver.

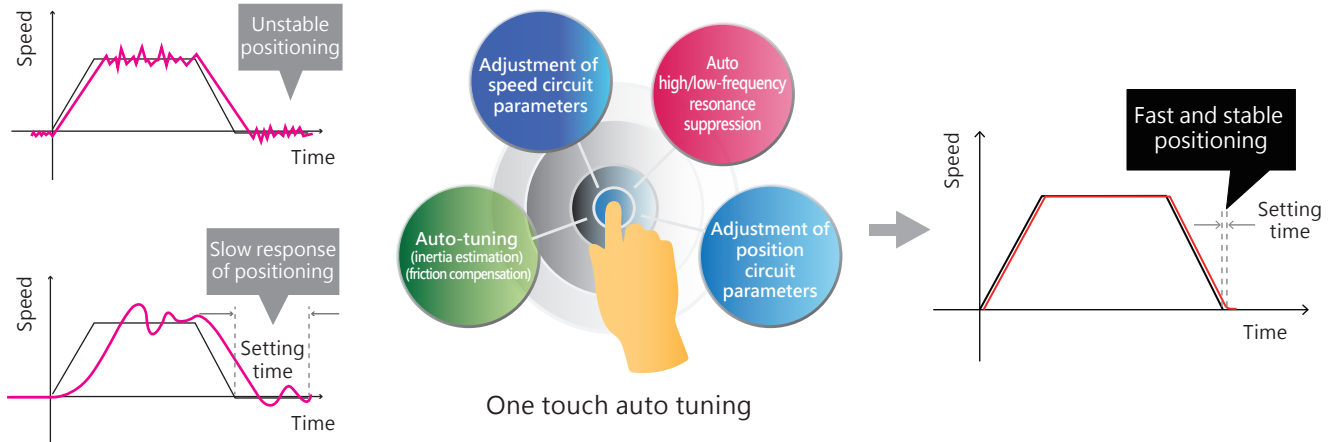

Faster response

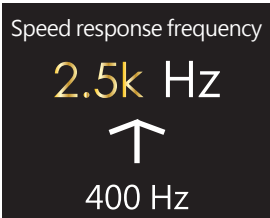

With outstanding speed response, it can greatly shorten the setting time to 1ms, featured by high speed, high response and accurate positioning.

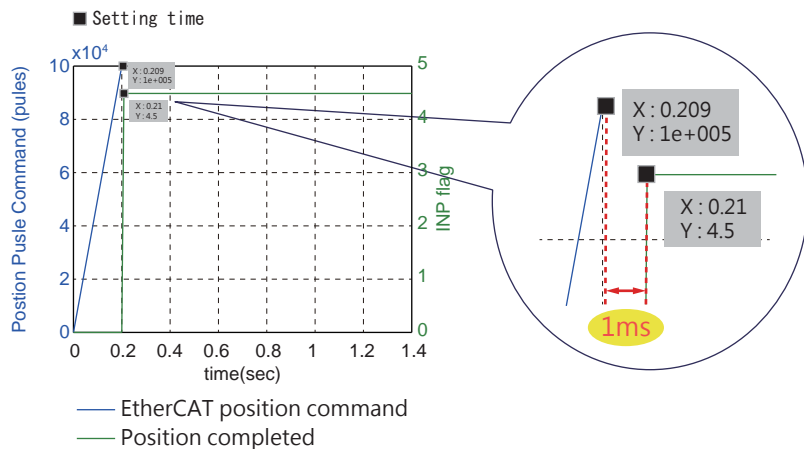

High-resolution



It is equipped with Japanese high-level absolute position encoder. The resolution is up to 16777216 pulse/rev. This can make the position control more accurate and improve the stability at low speed.

Auto friction compensation

It can effectively reduce the position deviation when the running motor changes direction, and also increase the stability when running at low speed.

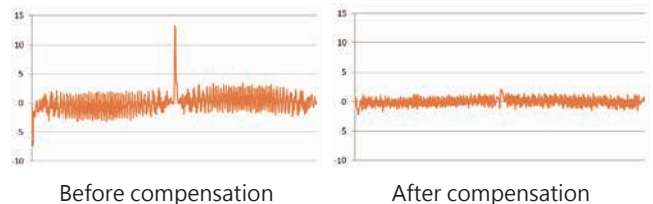

Features

Suppress resonance frequency and vibration

To inertia system of mechanical, both two low-frequency vibrations could be suppressed at the same time by vibration control algorithms. This can suppress the residual vibration from the end of arm to main body. Automatic high/low-frequency vibration suppression function could be turned on directly in motion mode, which can search for the vibration frequency and turn on the filter, so as to suppress the mechanic resonance. This can further shorten the setting time and improve equipment performance.

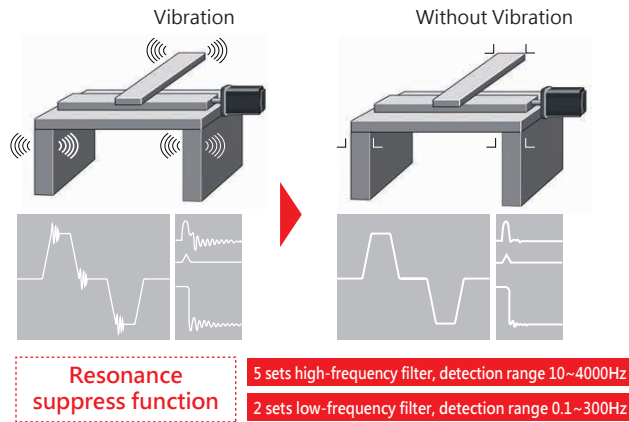

Friction compensation and backlash compensation

It improves the commutation error effectively and increases the circularity.

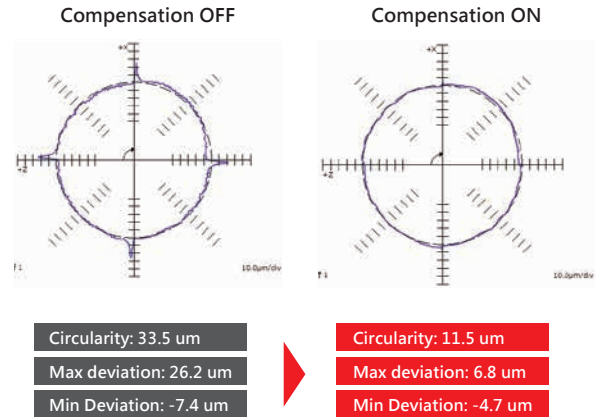

Motor diversification and performance enhancement

① The motor cogging torque lower than 1.5% increases the smoothness of running at fixed speed and processing at low speed, which achieves the reduction of 25% than SMA in the past.

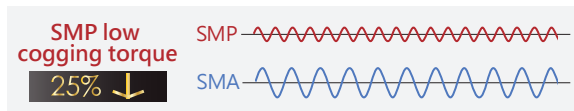

② Speed increasing and better torque output help to enhance the performance (productivity).

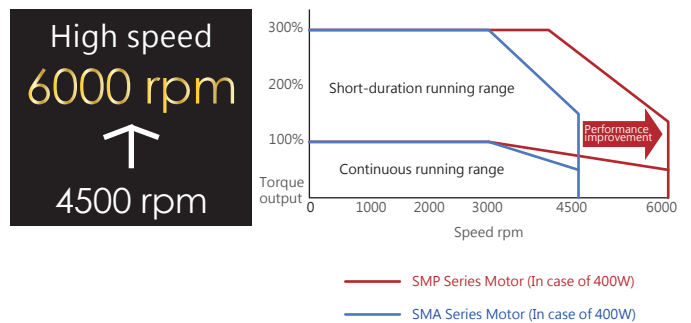

Absolute Position System Optional



Use optional battery to memory absolute position when power-off. (Absolute motor and battery are optional)

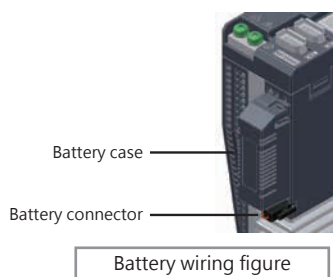

Safe Torque Off (STO)

STO function is supported to enhance the integrity of equipment and factory safety.

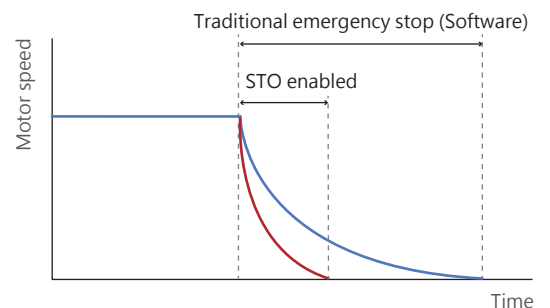

Electronics cam

The cam profile can be planned as high as 720 points, which can be applied in cam control of printing machine/labeling machine/packaging machine/fly shearing/cutting/and etc.

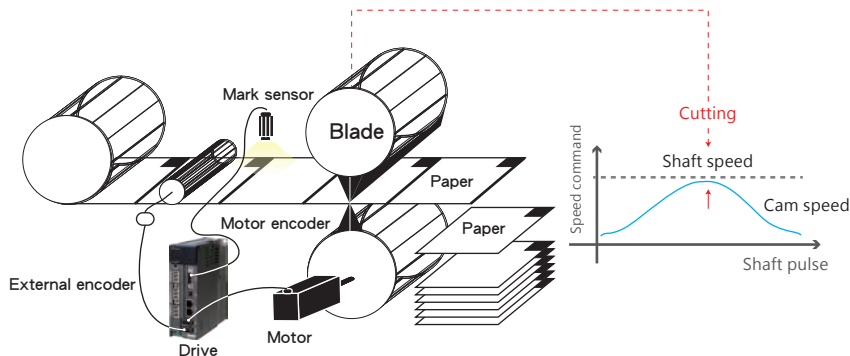

Full-closed Loop Control

It can be connected with external optical scale or encoder, and control the position accurately through signal of terminal position feedback, so as to reduce the impact of backlash and flexibility of the transmission mechanism, ensuring the positioning accuracy on machine end.

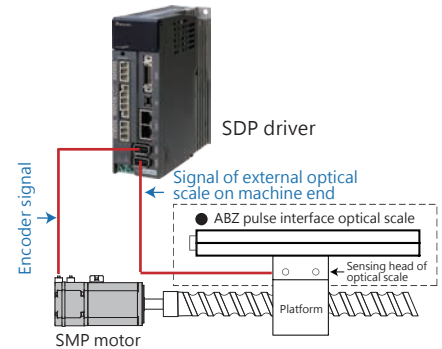

ETG Certification

With international certification, it guarantees the performance and functionality.



Unique among Taiwan's manufacturers

Shortest communication cycle time in the industry

It can support minimum 100us cycle time, achieving High-speed and High precision in motion control.

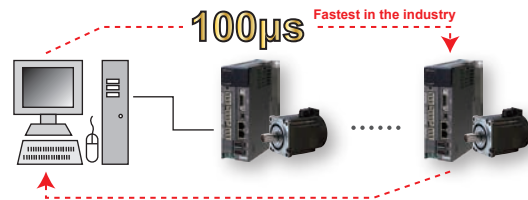

Model Definition

Servo Motors Model Definition

Series	Inertia	Motor capacity			Motor Rated Rotation	Encoder resolution	With brake and Oil Seal	Key and Cable	
SMP-L	Low inertia	005	50W	100	1KW	20	2000	A	No key/Cable leading load side
	Medium inertia	010	100W	150	1.5KW	30	3000	B	With key/ Cable leading load side
SMP-M	Medium inertia	020	200W	200	2KW			C	No key/Cable leading opposite load side (Optional)
		040	400W	300	3KW			D	With key/Cable leading opposite load side (Optional)
		075	750W	500	5KW				
		700	7KW						

Servo Drives Model Definition

Series	Motor Capacity			Input Voltage	Model code
SDP-010	010	100W	100	1KW	C
	020	200W	150	1.5KW	
	040	400W	200	2KW	
	075	750W	300	3KW	
			500	5KW	
		700	7KW		

Servo Motor Specifications

Small Capacity Low Inertia / Medium Capacity Low Inertia

Servo motor model SMP - L□□□	Unit	005	010	020	040	075	100	150	200	300	
Corresponding drive model SDP - □□□E2C		010			020	040	075	100	150	200	300
Rated output capacity	W	50	100	200	400	750	1000	1500	2000	3000	
Rated torque ^(Note 1)	Nm	0.16	0.32	0.64	1.27	2.4	4.78	7.16	9.55	14.3	
Maximum torque	Nm	0.48	0.96	1.92	3.81	7.2	14.4	21.6	28.5	43.0	
Rated speed	rpm	3000					2000				
Maximum speed	rpm	6000					3500				
Rate current	A	0.43	0.85	1.7	2.8	5.8	5.8	8.5	11	16	
Maximum current	A	2.7	2.7	5.2	9.0	18.5	17.4	25.2	33	48	
Rotary inertia J (x10 ⁻⁴) ^(Note 2)	kg·m ²	0.0295 (0.0299)	0.0518 (0.0523)	0.161 (0.178)	0.277 (0.294)	1.07 (1.11)	6.1 (8.0)	8.8 (10.7)	11.5 (13.5)	16.7 (18.7)	
Power rate at continuous rated	kW/s	8.6	19.6	25.2	58.5	53.3	37.6	58.3	79.3	122.9	
Insulation class	--	CE(B)					CE(F)				
Insulation resistance	--	100MΩ @ DC 500V									
Insulation voltage	--	60sec @ AC 1500V									
Encoder resolution	--	Resolution 24bit (16,777,216 Pulse)					Resolution 23bit (8,388,608 Pulse)				
Structure ^(Note 3)	--	Totally enclosed, natural cooling (IP rating: IP65) ^(Note 4)									
Vibration rank	--	V-15									
Environment	Storage temperature	0°C ~ 40°C(non freezing) / Storage:-15°C ~ 70°C(non freezing)									
	Storage Humidity	Below 80%RH (non condensing) / Storage : Below 90%RH (non condensing)									
	Altitude	Between sea level and 1000 m									
	Ambience	Indoor (avoid direct sunlight); no corrosive gas, no flammable gas, no oil mist or dust									
	Vibration Resistance	5G					2.5G				
Permissible load for the shaft ^(Note 4)	Fd	20			25		35		50		
	Radial load Fr	68.6			245		392		490		
	Axial load Fa	39.2			98		147		196		
Electromagnetic brake specification ^(Note 5)	Input	V DC 24V ± 10%									
	Brake	0.3			1.3		2.4		8.5		15
	Power consumptio	6.3			7.9		8.6		19.3		19.3
	Current consumptio	0.24			0.32		0.35		0.8		0.8
	Resistor@20°C	Ω 92.4			75.4		67		29.8		29.8
	Open time	ms 20			30		50		40		40
	Close time	ms 20			20		20		25		25
Weight ^(Note 6)	kg	0.33 (0.55)	0.45 (0.67)	0.85 (1.23)	1.23 (1.59)	2.24 (2.87)	5.2 (7.0)	6.5 (8.3)	7.7 (9.5)	10.2 (12.0)	

Note 1 : For the motion mechanism of lifting axis or reciprocating load, it is recommended keeping the load rate below 75%.

Note 2 : () is the rotary inertia and weight for the models with electromagnetic brake.

Note 3 : IP rating 65 is for the motor body only, not including the output axis and connector.

Note 4 : The permissible load for the shaft is as shown in the figure on the right.

Note 5 : The brake is used to stop or fix the machine, which can't be used for braking the motion mechanism.

Note 6 : () is the weight of the electromagnetic brake.

Diagram of permissible load for the shaft

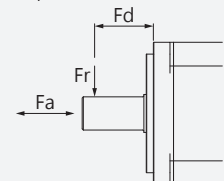

Medium Capacity Medium Inertia

Servo motor model SMP - M□□□20	Unit	100	150	200	300	500	700
Corresponding drive model SDP - □□□E2C		100	150	200	300	500	700
Rated output capacity	W	1000	1500	2000	3000	5000	7000
Rated torque ^(Note 1)	Nm	4.78	7.16	9.55	14.3	23.9	33.4
Maximum torque	Nm	14.4	21.6	28.5	43.0	71.7	100.2
Rated speed	rpm	2000					
Maximum speed	rpm	3500				2000	
Rate current	A	5.8	8.5	11	16	22	30
Maximum current	A	17.4	25.2	34.7	48	66	90
Rotary inertia	kg·m ²	10.3 (12.2)	15.0 (17.0)	32.1 (42.4)	61.2 (71.6)	84.6 (95)	121.6 (132)
Power rate at continuous rated	kW/s	22.1	34.2	28.4	33.5	68	92
Insulation class	--	CE(F)					
Insulation resistance	--	100MΩ @DC 500V					
Insulation voltage	--	60sec @ AC 1500V					
Encoder resolution	--	Resolution 23bit (8,388,608 Pulse)					
Structure ^(Note 3)	--	Totally enclosed, natural cooling (IP rating: IP65) ^(Note 4)					
Vibration rank	--	V-15					
Environment	Storage temperature	--	0°C ~ 40°C(non freezing) / Storage:-15°C ~ 70°C(non freezing)				
	Storage Humidity	--	Below 80%RH (non condensing) / Storage : Below 90%RH (non condensing)				
	Altitude	--	Between sea level and 1000 m				
	Ambience	--	Indoor (avoid direct sunlight); no corrosive gas, no flammable gas, no oil mist or dust				
	Vibration Resistance	--	2.5G				
Permissible load for the shaft ^(Note 4)	Fd	mm	50	70	78		
	Radial load Fr	N	490	980			
	Axial load Fa	N	196	392			
Electromagnetic brake specification ^(Note 5)	Input	V	DC 24V ± 10%				
	Brake	Nm	8.5	45			
	Power consumptio	W	19.3	34			
	Current consumptio	A	0.8	1.41			
	Resistor@20°C	Ω	29.8	17			
	Open time	ms	40	110			
	Close time	ms	25	30			
Weight ^(Note 6)	kg	5.6 (7.4)	6.9 (8.7)	10.5 (15.8)	15.3 (20.6)	19.1 (24.4)	24.5 (29.8)

Note 1 : For the motion mechanism of lifting axis or reciprocating load, it is recommended keeping the load rate below 75%.

Note 2 : () is the rotary inertia and weight for the models with electromagnetic brake.

Note 3 : IP rating 65 is for the motor body only, not including the output axis and connector.

Note 4 : The permissible load for the shaft is as shown in the figure on the right.

Note 5 : The brake is used to stop or fix the machine, which can't be used for braking the motion mechanism.

Note 6 : () is the weight of the electromagnetic brake.

Diagram of permissible load for the shaft

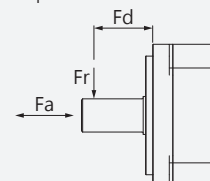

Servo Drive Specifications

Servo drive model SDP-□□□E2C		010	020	040	075	100	150	200	300	500	700	
Servo motor model SMP-□□□□		L005	L020	L040	L075	L100	L150	L200	L300	M500	M700	
		L010				M100	M150	M200	M300			
Servo motor power		50W	200W	400W	750W	1.0KW	1.5KW	2KW	3KW	5KW	7KW	
		100W										
Main Circuit Power	Input	Voltage 50/60Hz	1-phase or 3-phase AC 200~240V						3-phase AC 200~240V			
		Permissible Voltage Fluctuation 50/60Hz	1-phase or 3-phase AC 170~264V						3-phase AC 170~264V			
		Permissible Frequency Fluctuation	±5%									
	Output	Voltage	AC 0~240V									
		Current	1.0A	1.8A	3.2A	5.4A	6.4A	9.4A	12.1A	17.6A	21.2A	30.2A
		Frequency	0~250Hz									
Control Circuit Power	Voltage 50/60Hz	1-phase AC 200~240V										
	Permissible Voltage Fluctuation 50/60Hz	1-phase AC 170~264V										
	Permissible Frequency Fluctuation	±5%										
	Power Consumption (W)	30										
Control Method		3-phase full wave rectify, IGBT-PWM controlled (SVPWM drive)										
Dynamic brake		Built-in (hardware)										
Protective Functions		Overcurrent, low voltage, overvoltage, overheat, overload protection (electronic heat accumulation), fan failure protection, encoder error protection, regenerative error, overspeed protection, error excessive protection, serial communication error, serial communication time out, motor match error, motor UVM disconnection, and control circuit error.										
Encoder Feedback		50W~750W: Incremental / Absolute 24bit / 1KW~3KW: Incremental / Absolute 23bit										
Communication Interface		EtherCAT · USB										
(CSP) Position Control Mode	Command Control	EtherCAT communication control										
	Command Smoothing	Low-pass filter / Linear / PS curve										
	Command Pulse Multiplying factor	Electronic gear A/B ratio A: 1~4194304, B: 1~4194304 (Limitation:1/50 < A/B < 64000)										
	Error Excessive	±3 rotations										
	Torque Limit	EtherCAT communication control										
	Feedforward Compensation	Internal parameter setup or EtherCAT communication control (0~200%)										
(CSV) Speed Control Mode	Speed Control Range	1:5000										
	Command Control	EtherCAT communication control										
	Command Smoothing	Low-pass filter / Linear acceleration and deceleration curve / S curve										
	Speed Fluctuation Rate	Load fluctuation 0~100%(maximum) ±0.01% power fluctuation ±10%(maximum)0.01%										
	Torque Limit	EtherCAT communication control										
	Bandwidth	Maximum 2.5KHz										
Torque Limitation Mode	Command Control	EtherCAT communication control										
	Command Smoothing	Low-pass filter										
	Speed Limit	EtherCAT communication control										
Input and Output Signals	Digital Input	Servo on, forward and backward inhibit limits, pulse error clear, torque direction selection, speed command selection, positioning command selection, forward and backward rotation direction selection, proportion control switching, torque limit switching, abnormal alarm reset, emergency stop, forward/reverse inhibit limit, control										
	Digital Output	Torque limit reached, speed limit reached, reserved signal, zero speed reached, position reached, speed reached, alarm display, alarm signal, homing completed, overload level arrived, internal position arrived, position command overflow, forward software limit arrived, reverse software limit arrived, capture program completed, E-CAM master position area										
Environment	Temperature	0°C~55°C (Force air circulation in the surrounding area if the temperature goes beyond 45 °C);Storage: -20~65°C (non freezing)										
	Humidity	Maximum 90% RH (non condensing) ; Storage: Below 90% RH (non condensing)										
	Installation Location	Indoor (avoid direct sunlight); no corrosive gas, no flammable gas, no oil mist or dust										
	Altitude	Between sea level and 1000 m										
	Vibration	Maximum 5.9m/s2										
Cooling System		Natural cooling, open					Fan cooling, open					
Weight (kg)		1.4			1.7		2.6		5.9			

Wiring Diagram

COE Mode : EtherCAT Mode

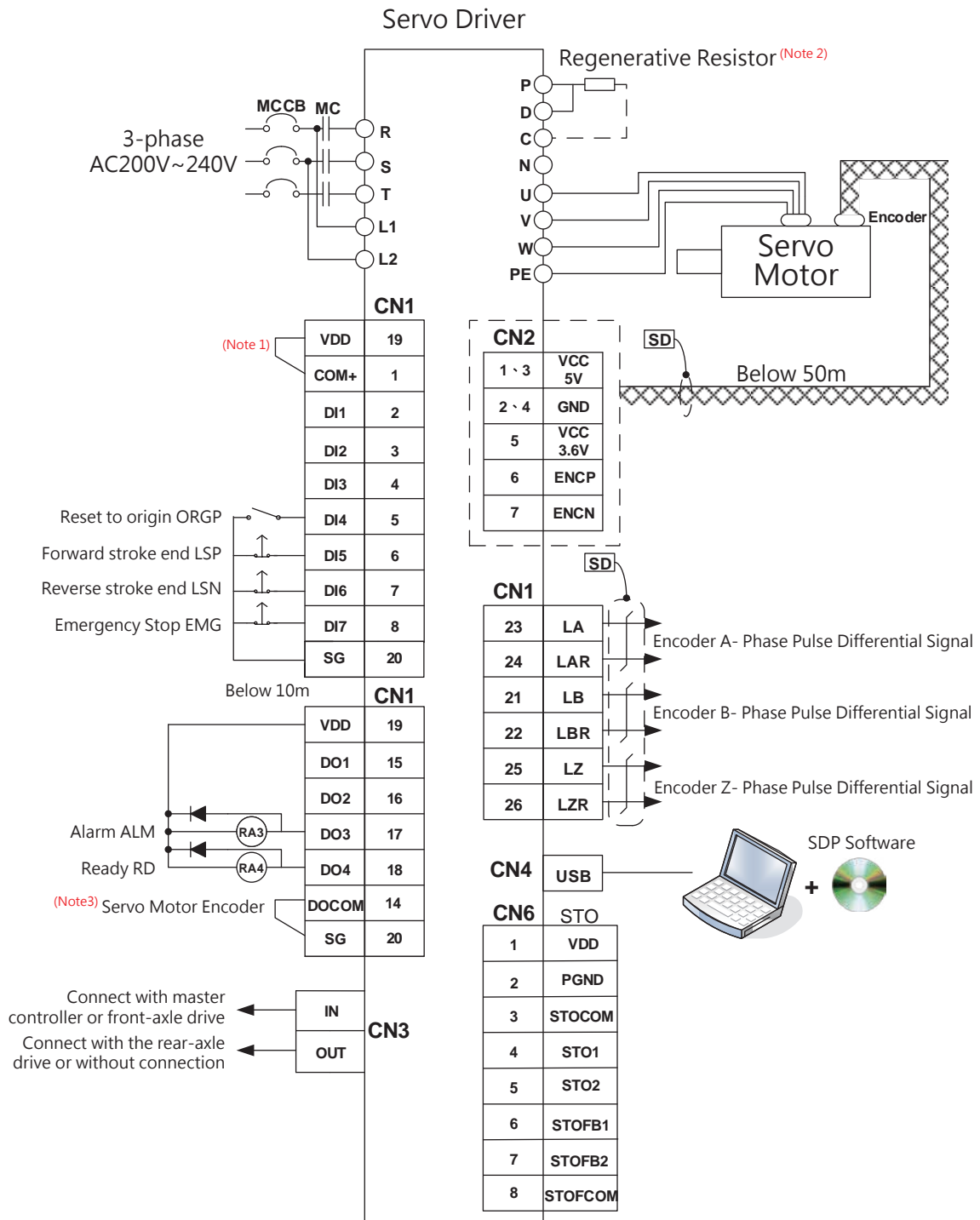

Notes

- Note 1 :** If external power is used, VDD cannot be connected to COM +.
- Note 2 :** Please refer to the manual for the wiring of regenerative resistor and brake units.
- Note 3 :** Please refer to the manual for the Sink Type and Source Type DO output wiring.

Wiring Diagram

Pr Mode: Built-in Single-axis Control Mode

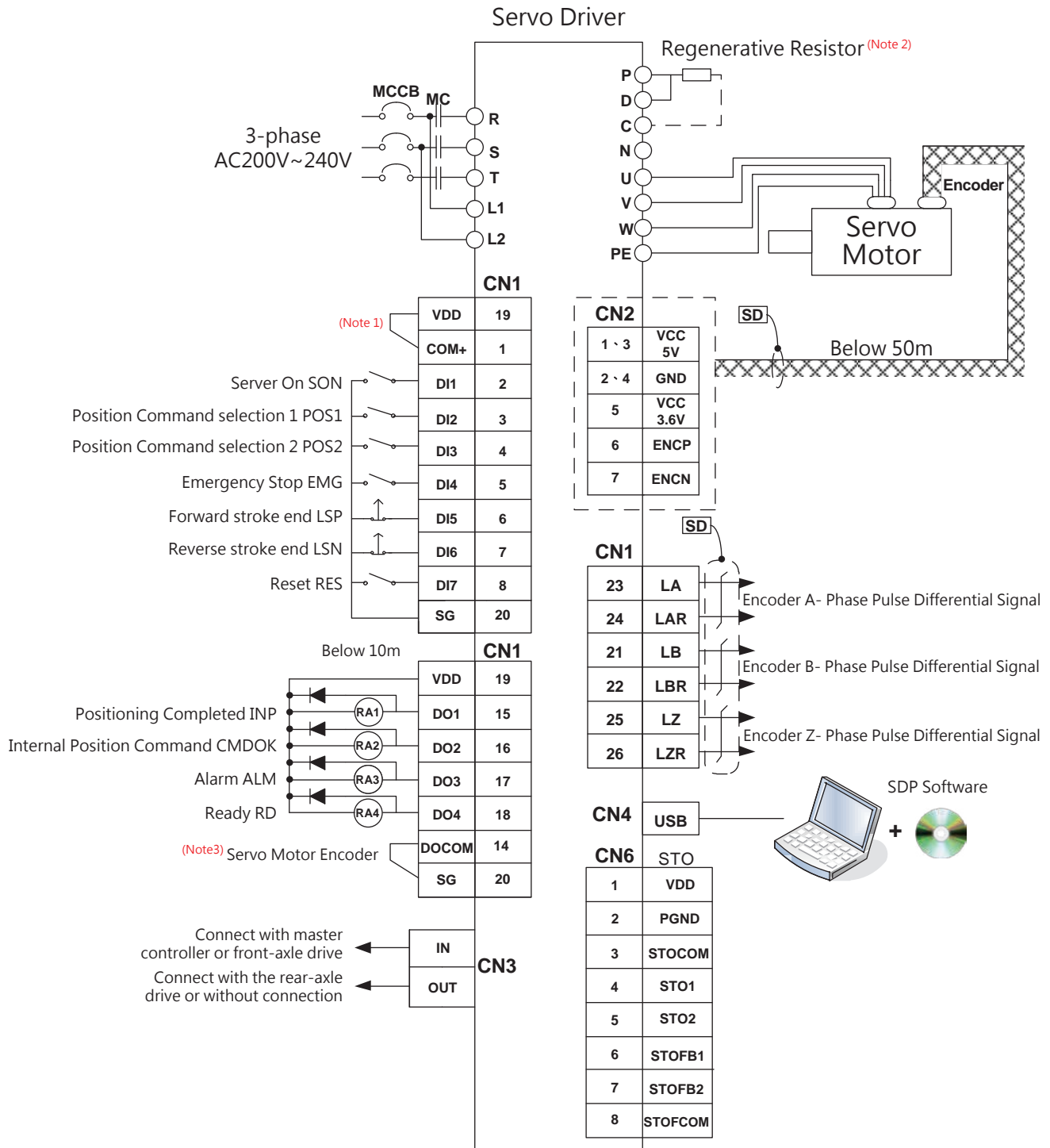

Notes

- Note 1** : If external power is used, VDD cannot be connected to COM +.
- Note 2** : Please refer to the manual for the wiring of regenerative resistor and brake units.
- Note 3** : Please refer to the manual for the Sink Type and Source Type DO output wiring.

S Mode: Speed Control Mode

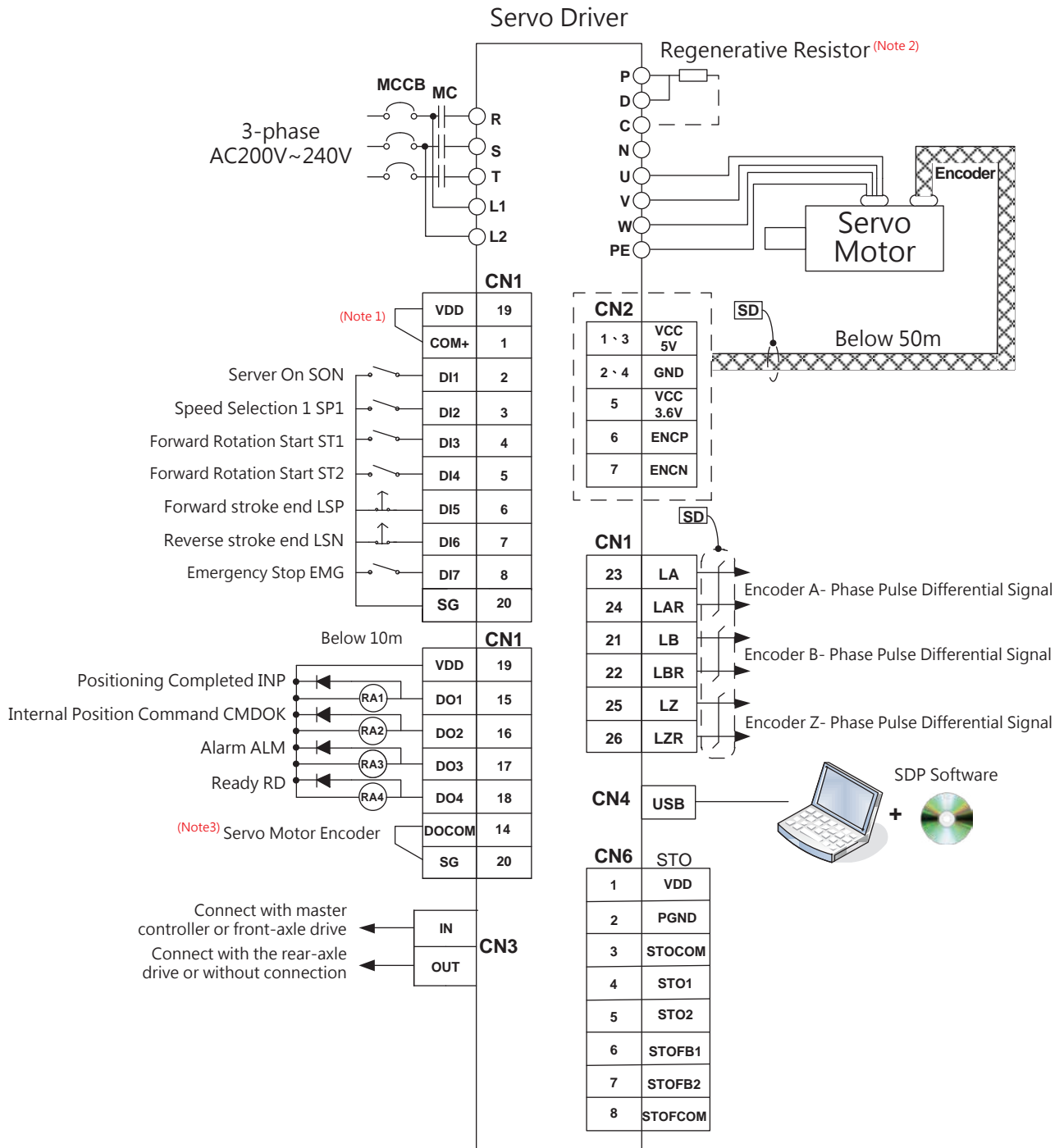

Notes

- Note 1 :** If external power is used, VDD cannot be connected to COM +.
- Note 2 :** Please refer to the manual for the wiring of regenerative resistor and brake units.
- Note 3 :** Please refer to the manual for the Sink Type and Source Type DO output wiring.

Connections with Peripheral Equipment

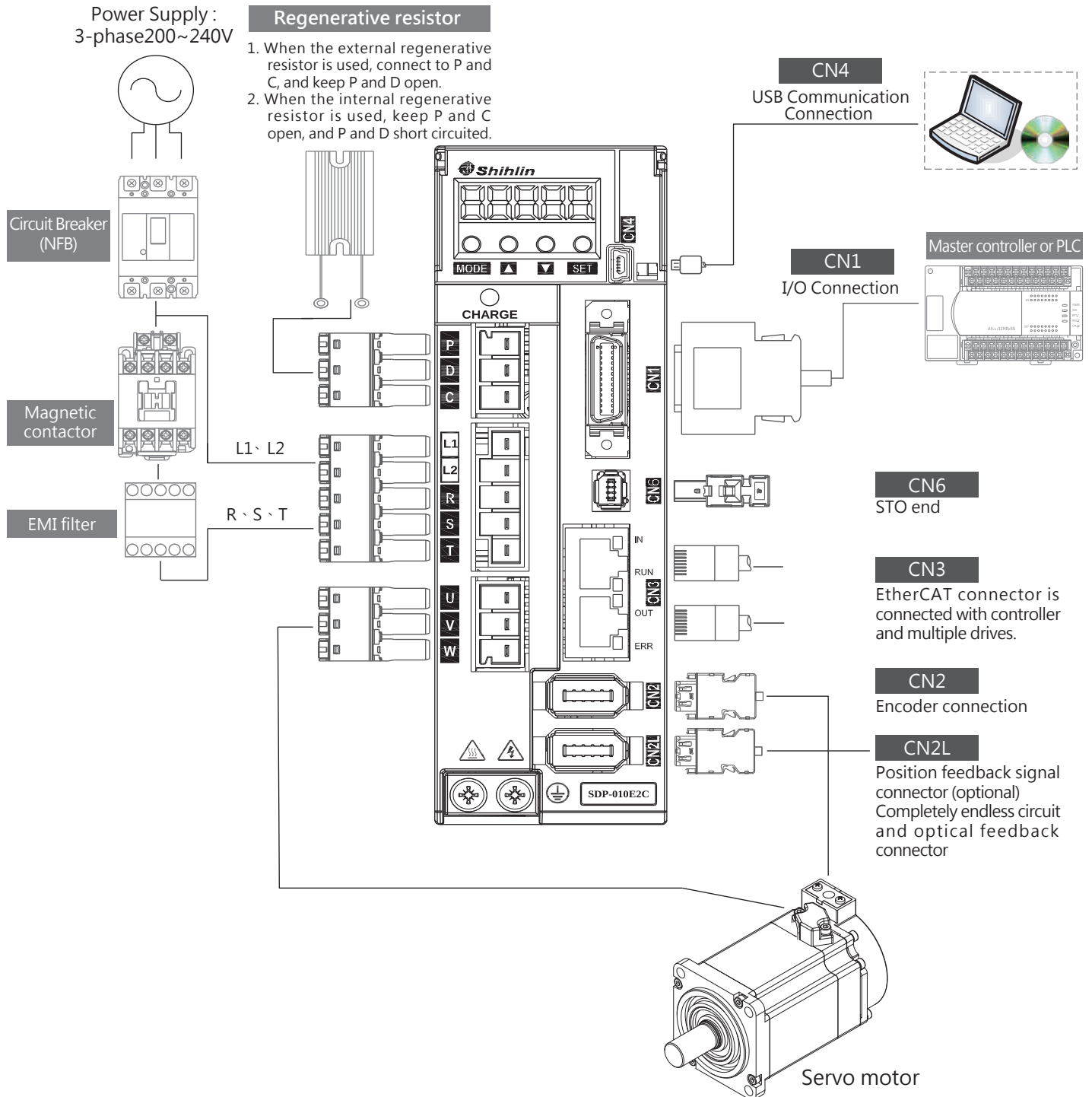

Notes

1. Connect external regeneration unit, please remove P and D short circuit line and connect external resistor to P · C point. Every capacity has its related resistor value, please refer to "Instruction Manual" .
2. Dedicated power cable is necessary with a brake motor, the exclusive power cable must be prepared and requires inputting DC24V power. Please don't use drive internal VDD connector for power. Please refer to "Operation Manual" for details.
3. The usage of absolute position, please select the optional battery " SDH-BAT-SET" .

Servo Drive Dimensions

Unit : mm

SDP-005E2C、SDP-010E2C
SDP-020E2C、SDP-040E2C

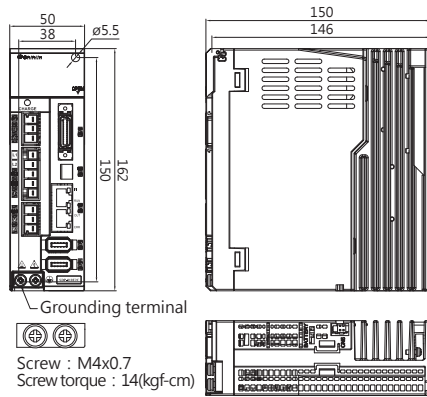

SDP-075E2C、SDP-100E2C

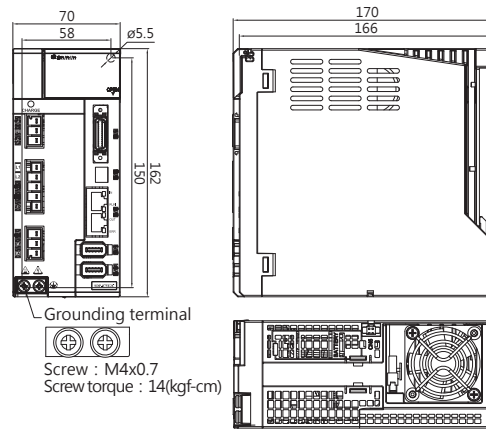

SDP-150E2C、SDP-200E2C
SDP-300E2C

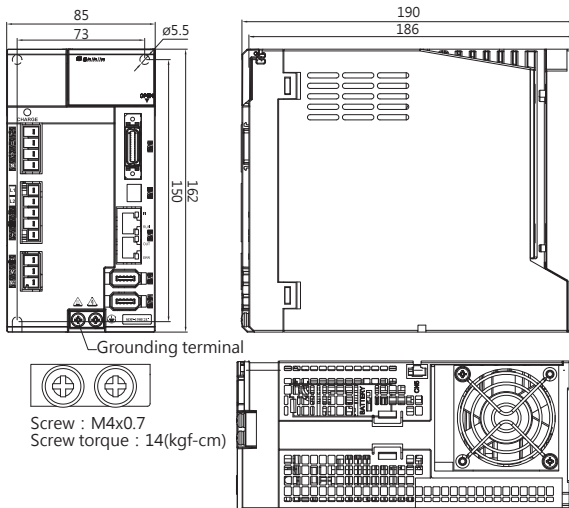

SDP-500E2C

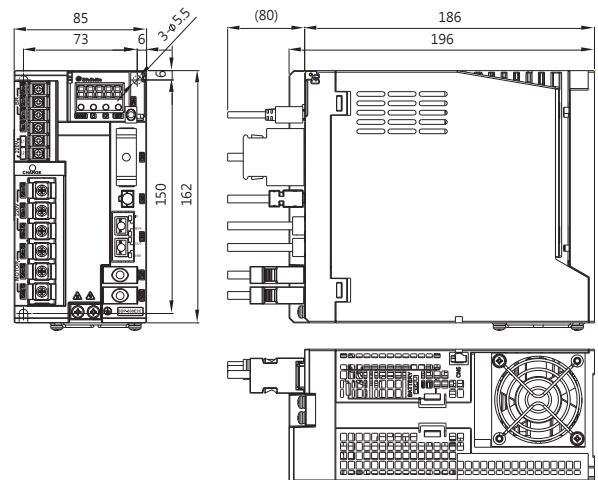

SDP-700E2C

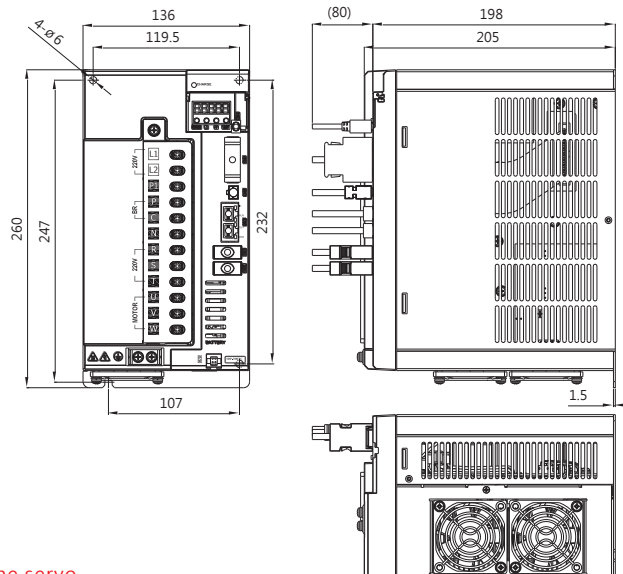

Note : Dimensions and weights of the servo drive may be revised without prior notice. Please refer to Shihlin official website.

Servo Motor Torque Curves

SMP-L□□□30 series torque characteristics*

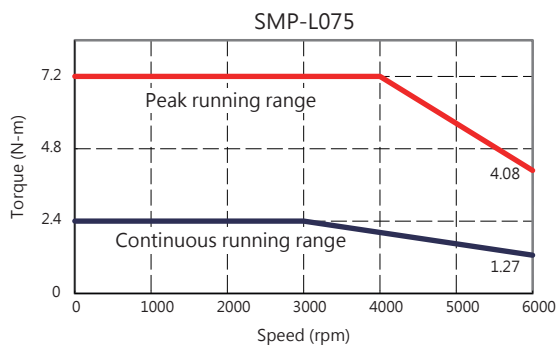
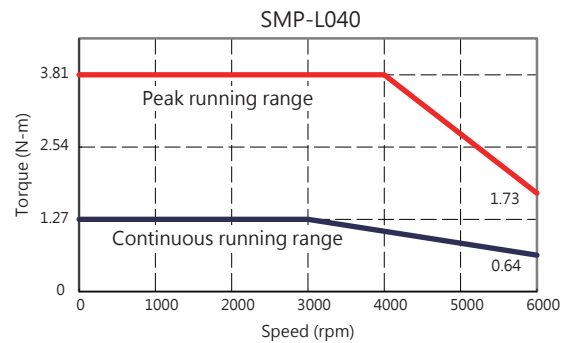
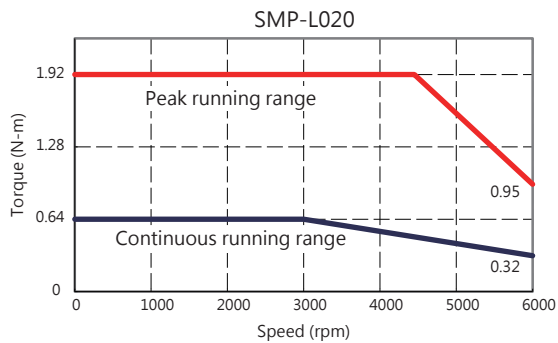
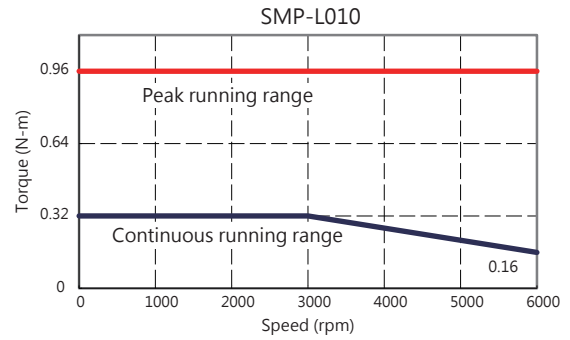
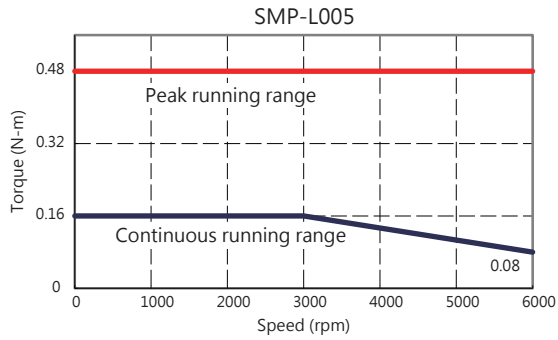

* Above is the torque characteristic curve for motor with the power 3-phase 220V.
When the voltage is insufficient, the torque characteristic will be reduced.

SMP-L□□□20 series torque characteristics*

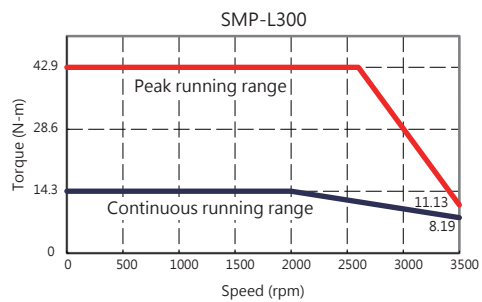
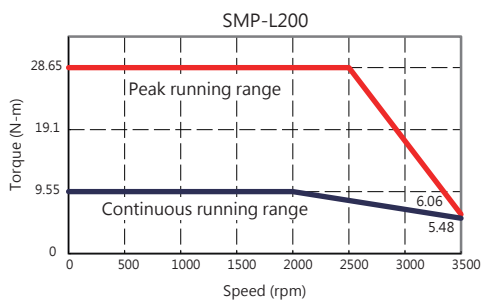
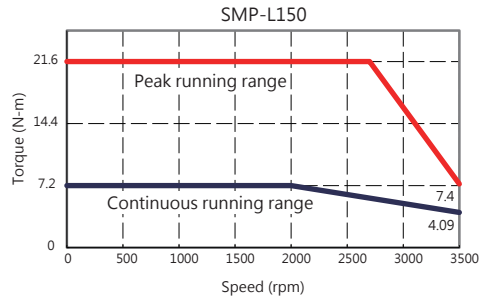
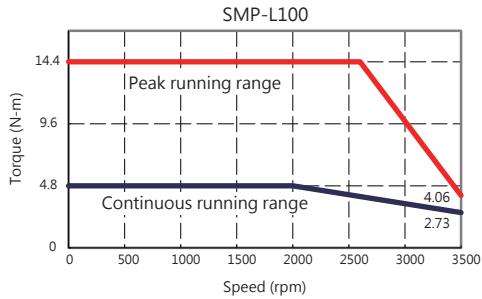

* Above is the torque characteristic curve for motor with the power 3-phase 220V. When the voltage is insufficient, the torque characteristic will be reduced.

SMP-M□□□20 series torque characteristics*

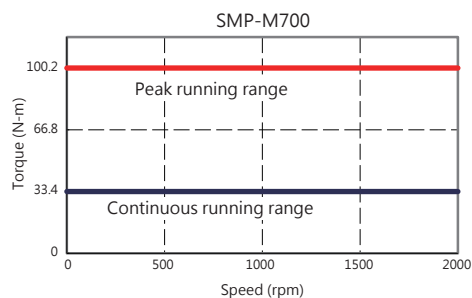
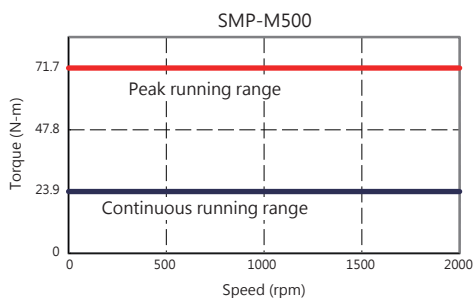
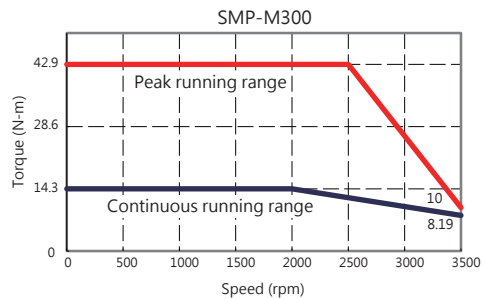
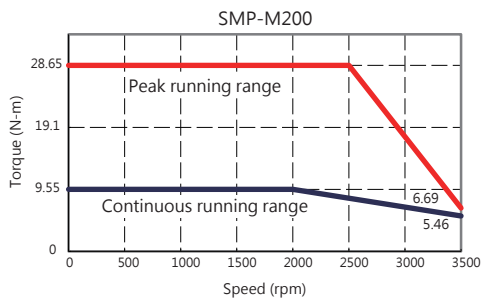
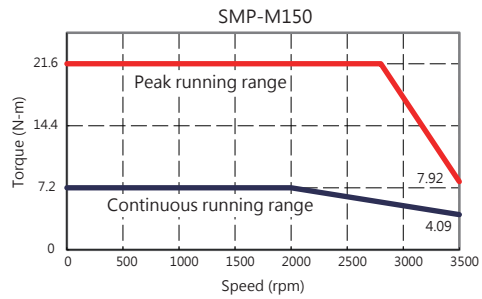
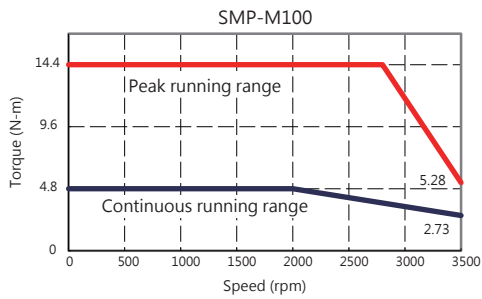

Dimensions

Small Capacity, Low Inertia SMP-L□□□30

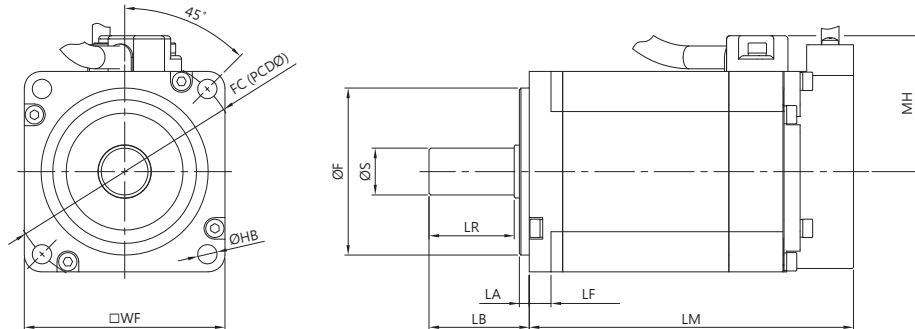

Model	Variable dimensions (mm)										
	WF	ϕS	ϕF	LA	LB	LF	LR	MH	LM*	FC	HB
SMP-L005	40	$\phi 8^{0}_{-0.009}$	$\phi 30^{0}_{-0.03}$	2.5	25.5	5.5	21.5	31	64.5 (99.2)	46	2- $\phi 4.5$
SMP-L010									80.0 (114.7)		
SMP-L020	60	$\phi 14^{0}_{-0.011}$	$\phi 50^{0}_{-0.03}$	3	30	6.5	25	41	77.0 (112)	70	4- $\phi 5.8$
SMP-L040									97.0 (132)		
SMP-L075	80	$\phi 19^{0}_{-0.013}$	$\phi 70^{0}_{-0.03}$	3	40.7	7.5	35.5	51	102.0 (141)	90	4- $\phi 6.6$

*() Dimensions in brackets are for the models with electromagnetic brake.

Medium Capacity, Medium Inertia SMP-L□□□20

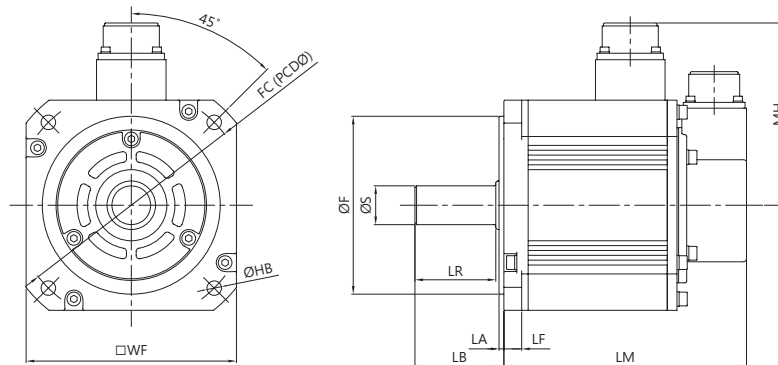

Model	Variable dimensions (mm)										
	WF	ϕS	ϕF	LA	LB	LF	LR	MH	LM*	FC	HB
SMP-L100	130	$\phi 24^{0}_{-0.013}$	$\phi 110^{0}_{-0.035}$	3	55	11	50	113	127 (161)	145	4- $\phi 9.0$
SMP-L150									141.5 (175.5)		
SMP-L200									156 (190)		
SMP-L300									185 (219)		

*() Dimensions in brackets are for the models with electromagnetic brake.

Medium Capacity, Medium Inertia SMP-M□□□20

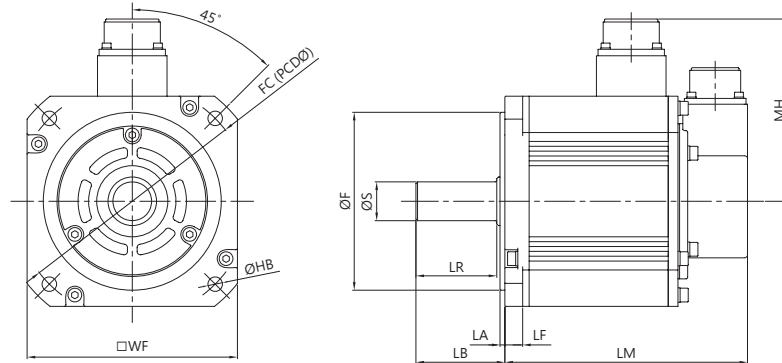

Model	Variable dimensions (mm)										
	WF	ϕS	ϕF	LA	LB	LF	LR	MH	LM*	FC	HB
SMP-M100	130	$\phi 24^{0}_{-0.013}$	$\phi 110^{0}_{-0.035}$	3	55	11	50	113	127 (161)	145	4- $\phi 9.0$
SMP-M150									141.5 (175.5)		
SMP-M200	176	$\phi 35^{0}_{-0.016}$	$\phi 114.3^{0}_{-0.025}$	3	78	18.5	74	139	139 (189)	200	4- $\phi 13.5$
SMP-M300									169 (219)		
SMP-M500									189 (239)		
SMP-M700									229 (279)		

Motor Shaft Dimensions

D-cut for L005 / L010

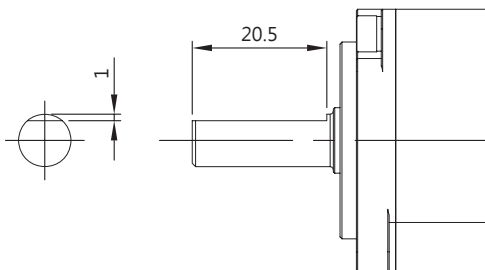



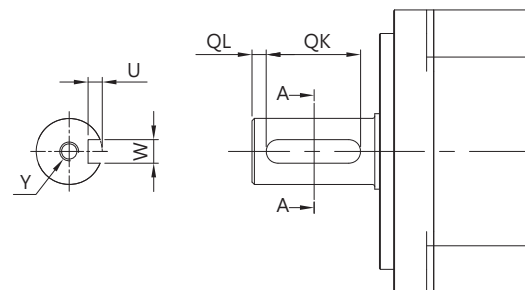





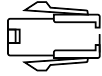
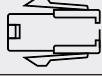

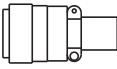

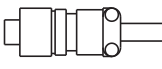
Key-way

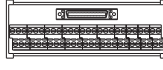
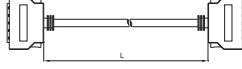

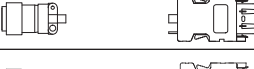
Model	Variable dimensions (mm)				
	QL	QK	W	U	Y
L020 / L040	3	20	$5^{0}_{-0.03}$	3	M4 x Depth 15
L075	5	25	$6^{0}_{-0.03}$	3.5	M5 x Depth 20
L100 / L150 / L200 / L300 M100 / M150	5	35	$8^{0}_{-0.036}$	4	M8 x Depth 20
M200 / M300 / M500 / M700	5	55	$10^{0}_{-0.036}$	5	M8 x Depth 20

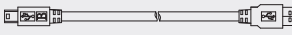
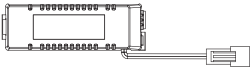
Optional Accessories

Item		Model	Content	SMP		
				L	M	
Motor cable	50W~750W No brake	Connector	SDA-PWCNL1		●	
		Cable	SDA-PWCNL1-□M-L/H *1 *2			
	50W~750W No brake	Connector	SDA-PWCNL2		●	
		Cable	SDA-PWCNL2-□M-L/H *1 *2			
	1KW/1.5KW 1K/1.5K/2K/3K	Connector	SDA-PWCNM1		●	●
		Cable	SDA-PWCNM1-□M-L/H *1 *2			
		Cable for electromagnetic brake	SDA-PWCNM2B-□M-L/H			
	2KW/3K	Connector	SDA-PWCNM2			●
		Cable	SDA-PWCNM2-□M-L/H *1 *2			
			SDA-PWCNM2-□M-L/H *1 *2			
Cable for electromagnetic brake	SDA-PWCNM2B-□M-L/H					
SMP-M 5kW/7kW	Connector	SDH-PWCNM4			●	
	Cable	5kW SDH-PWCNM4-□M-L/H				
		7kW SDH-PWCNM5-□M-L/H				
	Brake Connector	SDH-BKCNS1			●	
Brake Cable	SDH-BKCNS1-□M-L/H					
For CN1	I/O connector		SDP-CN1		●	●
	Terminal block and wire set		SDP-TB26		●	●
			SDP-TBL05M SDP-TBL1M SDP-TBL2M		●	●
For CN2	50W~750W	Connector	SDH-ENL		●	
		Cable	SDH-ENL-□M-L/H *1 *2			
	1KW~3KW	Connector	SDH-ENM		●	●
		Cable	SDH-ENM-□M-L/H *1 *2			
For CN2L	Fully closed loop	Connector	SDH-CN2		●	●
		Cable	SDH-CN2L-0.5M			
For CN3	USB communication cable		SDP-CN3-□M		●	●
For CN4	USB communication cable		SDA-USB3M		●	●
For CN5	Absolute encoder battery set		SDH-BAT-SET		●	●
	Absolute encoder battery set		SDH-BAT			
For CN6	STO communication cable		SDP-CN6-□M		●	●

*1 : □ Indicates the cable length. Standard: 2M · 3M · 5M · 10M; Special order: other length.

*2 : L and H indicate bending life. L: standard, H: long bending life.

EtherCAT Master Controller Information

Master Controllers

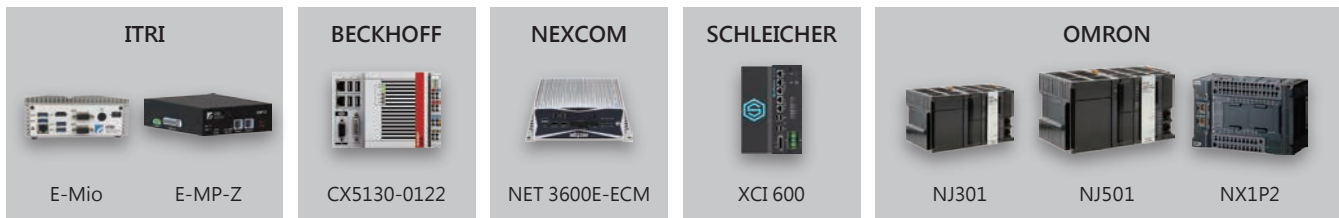

Controller



EtherCAT
Conformance tested

Shihlin SDP Series



Recommended Specification

Model	Talos-3012	Talos-2110	PCIe-8338	PCI-1203
Cycle time	250 / 500 / 1000 μ s	250 / 500 / 1000 μ s	250 / 500 / 1000 μ s	500 μ s
Supported axis	64	64	64	32
I/O points	External addition	4DI / 4DO	4DI / 4DO	8DI / 4DO

SDP Series AC SERVO SYSTEM

The Best Drive for Smart Machinery



Head Office:

16F, No. 88, Sec. 6, ChungShan N. Rd.,
Taipei, Taiwan, 111

TEL: +886-2-2834-2662

FAX: +886-2-2836-6187

HsinFun Factory (Taiwan)

No.234, ChungLun, HsinFun,
HsinChu, Taiwan, 304

TEL: +886-3-599-5111

FAX: +886-3-590-2167

SuZhou Factory (China)

No.88, Guangdong Street, Suzhou New District,
Jiangsu, China, 215129

TEL: +86-512-6843-2662

FAX: +86-512-6831-1917

Official website www.seec.com.tw
Automation Division website www.seecfa.com
automation@seec.com.tw

Specification in this catalog are subject to change without notice for ongoing product modification and improvements.
© 2018 Shihlin Electric & Engineering Corporation. All rights reserved.